



RT310RF THERMOSTAT - FULL USER MANUAL

 **SALUS**[®]
CONTROLS

TABLE OF CONTENTS

1. Introduction	4
1.1 Product Compliance	4
1.2 Safety Informations	4
2. Product Overview	5
2.1 Package content	6
2.2 Proper thermostat location	6
2.3 Wall mounting	7
2.4 Free-standing device	7
3. Before you start (first power up)	8
3.1 LCD icon description	8
3.2 Button description	8
3.3 First power up sequence and configuration	9
4. RXRT510 receiver	10
4.1 Receiver's switches description	10
4.2 LED indications in the receiver	11
4.3 Wall mounting of the receiver	12
4.4 Connection description	13
5. User settings	14
5.1 Manual mode - changing temperature setpoint	14
5.2 Frost protection mode	15
5.3 Sleep mode	15
5.4 Heat/Cool mode *	16
5.5 Temperatures outside operating range	17
5.6 Low battery detection	17
6. Installer mode	18
6.1 DIP switches parameters	18
7. RT310TX thermostat pairing with the receiver	19
8. Test the pairing process	20
9. Reset function	21
10. Cleaning and Maintenance	22
11. Technical Informations	22
12. Warranty	23

1. Introduction

1.1 Product Compliance

This product complies with the essential requirements and other relevant provisions of Directives 2014/53/EU and 2011/65/EU. The full text of the EU Declaration of Conformity is available at the following internet address: www.saluslegal.com.

1.2 Safety Informations

- Before starting installation work and before using the product, read the entire manual.
- The information contained in the instructions is essential for proper functioning.
- To avoid accidents resulting in personal injury and material damage, please follow all safety precautions, specified in this manual.
- The device should not be used by people with limited mental, sensory or mental abilities, without experience, of insufficient knowledge as well as children.
- Do not use an unassembled device (eg without a cover).
- The device may only be opened by a qualified person.
- Keep electrical devices out of the reach of children and ensure that they do not play with it. Children should not be left unattended. If necessary, disconnect the control system for the entire room.
- Do not leave the packaging, cabinet, or any loose parts of the device unattended, as they pose a risk to children.

WARNING!

- Installation must be carried out by a qualified person with appropriate electrical qualifications in accordance with standards and regulations in force in the given country and in the EU.
- Never try to connect the device other than as described in the manual.
- Before assembly, repair or maintenance as well as during any connection works it is absolutely necessary disconnect the mains supply and make sure that the terminals and electric wires are not live.
- The device may not be exposed to extreme temperatures, strong vibrations or subjected to mechanical shock.
- The device should not be used in unfavorable environmental conditions or in rooms where there is a concentration of flammable gases, fumes or dust.

WARNING!

- There may be additional protection requirements for the entire installation that the installer is responsible for maintaining.



Care for the natural environment is of paramount importance to us. The awareness that we manufacture electronic devices obliges us to dispose of used electronic components and devices safely. Therefore the company has received a registration number issued by the Chief Inspector for Environmental Protection. The crossed out symbol the trash can on the product means that the product must not be disposed of with ordinary waste containers. Sorting waste for recycling helps to protect the environment. It is the user's responsibility to surrender used equipment to a designated collection point for recycling waste from electrical and electronic equipment.

2. Product Overview

The RT310 room thermostat simply switches the heating system on and off as necessary. It works by sensing the air temperature, switching on the heating when the air temperature falls below the thermostat setting, and switching it off once this set temperature has been reached.

Turning a room thermostat to a higher setting will not make the room heat up any faster. How quickly the room heats up depends on the design of the heating system, for example, the size of boiler and radiators. Neither does the setting affect how quickly the room cools down. Turning a room thermostat to a lower setting will result in the room being controlled at a lower temperature, and saves energy.

The way to set and use your room thermostat is to find the lowest temperature setting that you are comfortable with, and then leave it alone to do its job. The best way to do this is to set the room thermostat to a low temperature – say 18°C – and then turn it up by one degree each day until you are comfortable with the temperature.

You won't have to adjust the thermostat further. Any adjustment above this setting will waste energy and cost you more money.

If your heating system is a boiler with radiators, there will usually be only one room thermostat to control the whole house. But you can have different temperatures in individual rooms by installing thermostatic radiator valves (TRVs) on individual radiators. If you don't have TRVs, you should choose a temperature that is reasonable for the whole house. If you do have TRVs, you can choose a slightly higher setting to make sure that even the coldest room is comfortable, then prevent any overheating in other rooms by adjusting the TRVs.

Room thermostats need a free flow of air to sense the temperature, so they must not be covered by curtains or blocked by furniture. Nearby electric fires, televisions, wall or table lamps may prevent the thermostat from working properly.

Product advantages:

- set factory-paired and ready to work
- has a TPI control algorithm
- automatically repeats the signal
- has a frost protection mode (temperature range 5 - 17 degrees)
- correction of the displayed temperature $\pm 3^{\circ}\text{C}$
- has a SLEEP mode (suspending the function, e.g. outside the heating season)
- has unique transmission codes
- operates at 868 MHz - a stable and noise-resistant signal
- heat/cool mode operation

2.1 Package content

- 1) RT310TX thermostat
- 2) RXRT510 receiver
- 3) Mounting bracket
- 4) 2x AA batteries
- 5) Short instruction
- 6) Mounting screws



2.2 Proper thermostat location

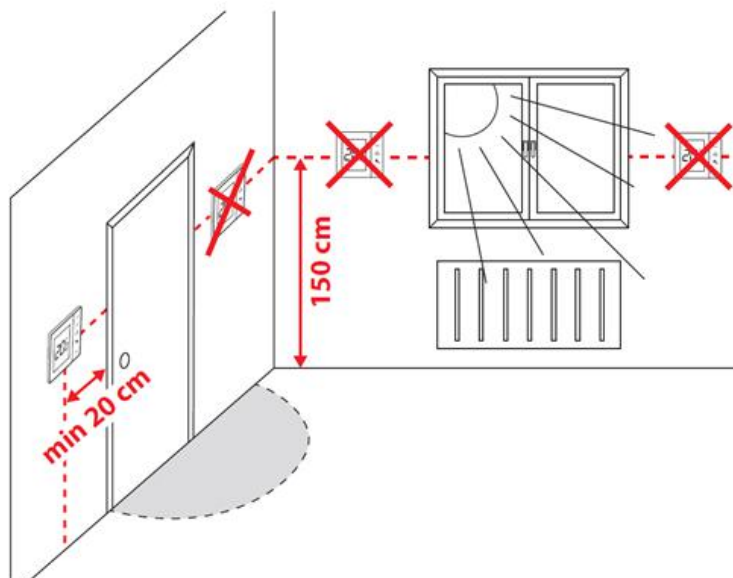

Please note:

The ideal position to thermostat mounting is about 1,5m under floor level far from heating or cooling sources. Thermostat can't be exposed to sunlight or any extreme conditions like for example draft.

Because of fire and explosion risk there is not allowed to use thermostat in atmosphere of explosive gases and flammable liquids (eg coal dust). In case if any of listed dangers occur you have to use additional protection measures – anti-dust and explosive gases (tight cover) or prevent their formation. Furthermore, thermostat can't be used in condensation of water vapor conditions and be exposed to water action.

2.3 Wall mounting

How to mount the thermostat to the wall:



2.4 Free-standing device

Thermostat can be used as a free-standing device (without need of wall mounting). Use a bracket included with the set as shown at the picture:



3. Before you start (first power up)

3.1 LCD icon description

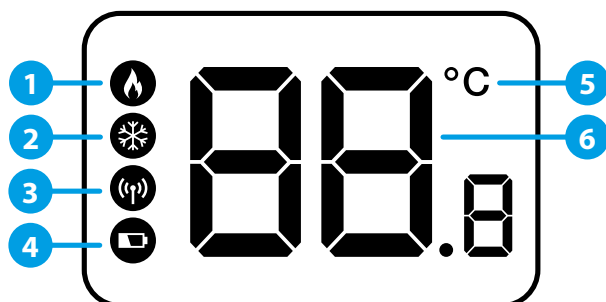

1. Heating Mode indication
2. Cooling Mode */Frost protection mode indication
3. RF signal indicator (only in RT310RF)
4. Low battery status
5. Temperature unit
6. Room / setpoint temperature

3.2 Button description



1. Turn on the LCD backlight
2. HEAT/COOL * modes change or Frost Protection mode activation (only when HEAT mode is enabled)
3. Increase button
4. Decrease button



PLEASE NOTE! The LCD screen can be activated by using any button.

* Function available only from firmware version 2.1

3.3 First power up sequence and configuration

To power up the thermostat you have to put the batteries inside. Then thermostat will display following sequence:

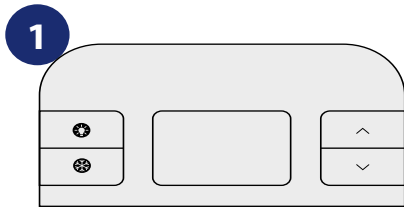

Remove the protection foil and insert 2xAA batteries by removing front cover.

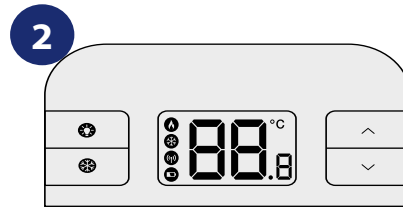

After that, thermostat will automatically power up and it will display all icons...

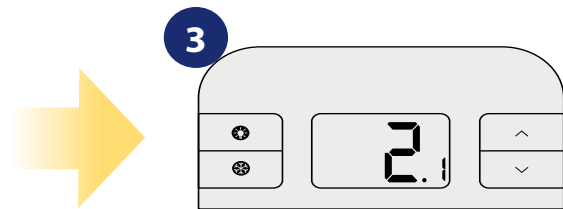

...then thermostat will display the software version.

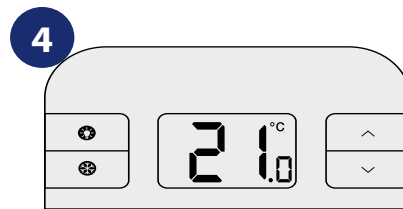

When thermostat is successfully powered up, main screen will be displayed.

4. RXRT510 receiver

The thermostat communicates wirelessly with the RXRT510 receiver. The receiver should be supplied with 230VAC, the maximum load of the receiver is 16A. Avoid installing the device in places directly exposed to water, moisture and air condensation. The RXRT510 receiver can operate in two different modes - AUTO (automatic) and MANUAL (manual). To select a specific mode, use the switches on the front of the receiver.



4.1 Receiver's switches description



TOP SWITCH	
1.	ON - Manual mode - receiver ON
2.	OFF - Manual mode - receiver OFF
BOTTOM SWITCH	
3.	AUTO - Receiver works in AUTO mode (according to the thermostat's command)
4.	MANUAL - Receiver works in manual mode (according to the ON/OFF switch)



For the receiver to work with the thermostat, set the switches to the ON / AUTO position.

4.2 LED indications in the receiver

The status of the RXRT510 receiver is indicated by two LEDs. These are LEDs with the following colors:

- 1 - red (upper one),
- 2 - green (lower one).



A detailed explanation of the meaning of the LEDs can be found in the table below:

	Wyjaśnienie
The red LED lights up	<p>The receiver is connected to the 230V power supply and is paired with the thermostat.</p> <p>The receiver can be thermostat-enabled if it is in automatic mode when the lower switch is in the AUTO position.</p> <p>The receiver can be started manually when the lower switch is in the MANUAL position.</p>
The red LED flashes	<p>The receiver is in standby mode, i.e. it has not received a signal from the thermostat within an hour. The set temperature on the thermostat was kept within the hysteresis and for such a condition the thermostat does not send a heating signal, because there is no such need.</p> <p>(or)</p> <p>The receiver is in the pairing mode and is looking for a signal from the thermostat (then you must activate the "PAIRING" option in the thermostat)</p> <p>(or)</p> <p>The receiver was paired but lost communication with the thermostat due to out of range or low battery in the thermostat. The receiver starts flashing after one hour of time when it does not receive a signal from the thermostat.</p>
The red diode is off	The receiver is disconnected from the 230V power supply or the upper switch is in the OFF position.
The green diode lights up	<p>In automatic mode, the receiver received a heating signal from the thermostat.</p> <p>The receiver was started in manual mode (upper ON switch, lower MANUAL switch)</p>
The green diode is off	The receiver does not send a heating signal.

4.3 Wall mounting of the receiver

Wall mounting the receiver: drill two $\varnothing 6$ mm holes in the wall. Insert the plugs and, by putting the plate to the wall (included in the set), put the two screws through the holes and then screw them in. Connect the necessary cables to the receiver. Next, hang the receiver on the board using the handles designed in the receiver, marked in the picture below.

ATTENTION! The set with the thermostat includes all necessary wirress, i.e. powering the receiver and connection to the boiler.



1
Loosen the screws with a screwdriver just enough to tilt the back housing.



2
Tilt the receiver cover upwards (according to the position of the „hinge“).

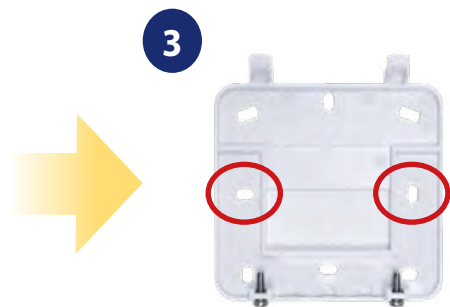

3
Attach the back housing to the wall (keeping the correct positioning of the plastic „hinges“) using the marked holes (see the picture above).



4
Then, correctly connect the wires with the receiver (see „connection diagrams“ on page 11).

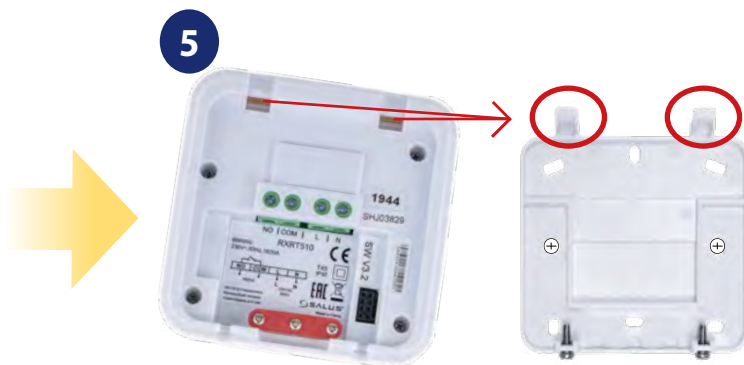

5
Put the receiver from above on the back housing attached to the wall, according to the position of the plastic „hinges“.

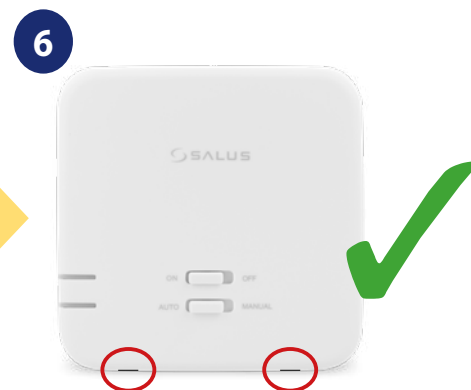

6
Tighten the screws from the bottom of the back housing to the receiver so that it is snug.

4.4 Connection description

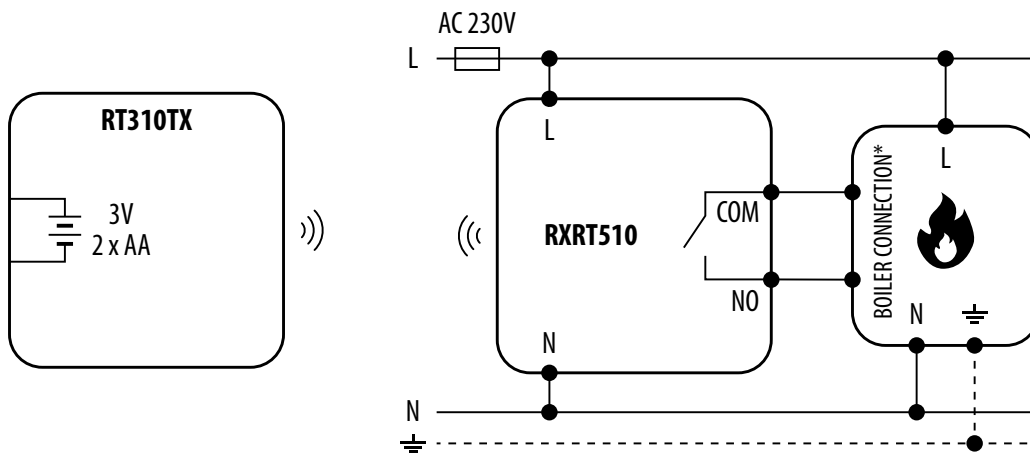

or

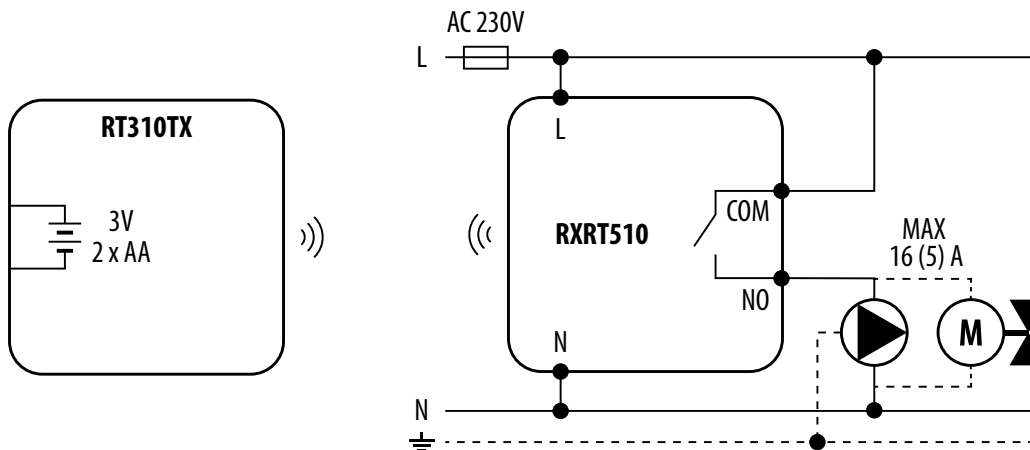

Legend:



Boiler - Boiler connection*
- Boiler's contacts for ON/OFF thermostat (according to the boiler's instructions)



Pump



Valve actuator

Symbols explanation:

L, N - power supply 230V

COM, NO - voltage-free output

 - fuse

5. User settings

5.1 Manual mode - changing temperature setpoint

In manual mode, the thermostat maintains a constant temperature set by the user. To set temperature setpoint follow steps below:

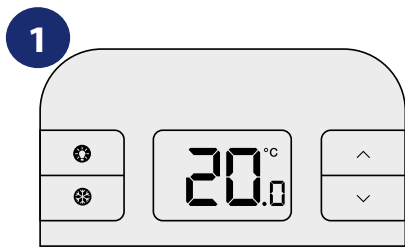

First, thermostat is displaying actual room temperature.

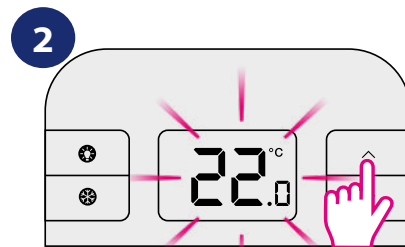

Press \wedge or \vee to set the new temperature setpoint.

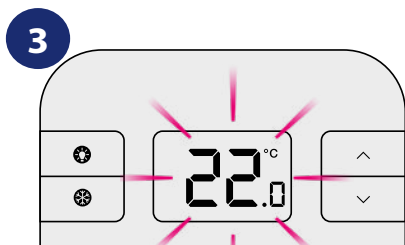

Now wait 2 seconds timeout to approve the changes.

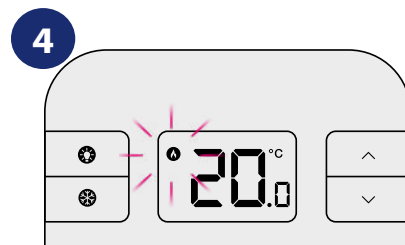

Thermostat will display room temperature again.

5.2 Frost protection mode

In this mode the setpoint temperature is automatically set to frost setpoint to prevent pipes from freezing. If the room temperature is lower than the frost setpoint, frost protection will be enabled. To set frost protection mode follow steps below:

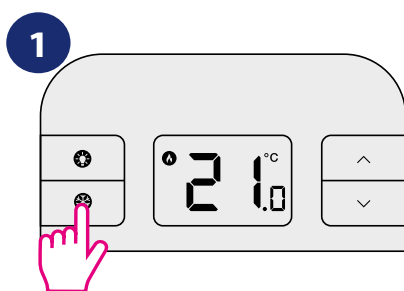

Press  button to turn ON/OFF frost protection.

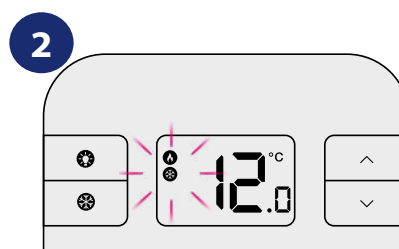

Snowflake icon will be displayed if frost protection is active.



The Frostpoint temperature can be reviewed by pressing the UP button once, but can only be changed in Installer Mode. Frost protection mode can be enabled only in HEAT mode.

5.3 Sleep mode

In sleep mode thermostat is switched off and doesn't consume any energy and it is impossible to make an action until you activate the thermostat again. To activate/deactivate sleep mode follow steps below:

TO ACTIVATE SLEEP MODE:

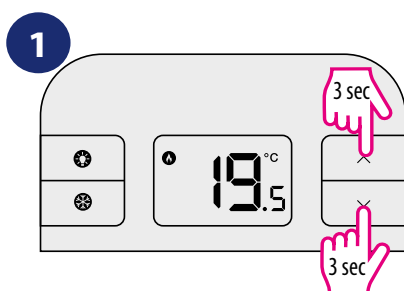

Press and hold ^ + v buttons simultaneously to turn ON sleep mode.

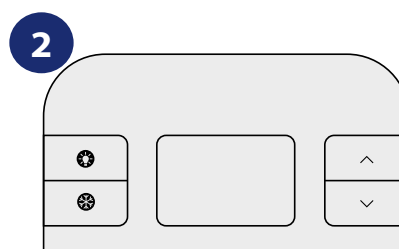

In sleep mode thermostat's display is blank.

TO DEACTIVATE SLEEP MODE:

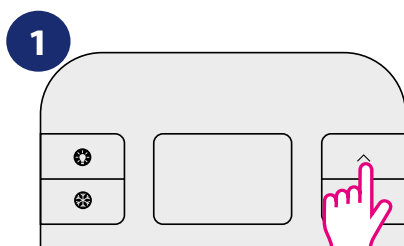

To deactivate sleep mode press any button.

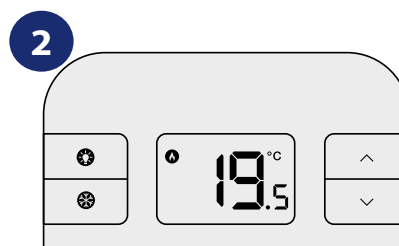

Thermostat will go back to work and display main screen.

5.4 Heat/Cool mode *

User can set thermostat for heating or cooling. In HEAT mode thermostat is displaying flame icon all the time. When thermostat is in HEAT mode and thermostat is CALLING for HEAT – the flame icon is flashing. In COOL mode thermostat is displaying snowflake icon all the time. When thermostat is switched to the COOLING mode and the thermostat is CALLING for COOL – then the snowflake icon is flashing. Default mode is HEAT MODE.

NOTE: every time when thermostat need to start call for cooling then it can be delayed for about 3 minutes.

To set selected mode please follow steps below:

HOW TO SET COOLING MODE:

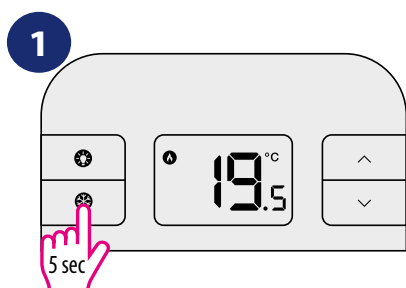

By default thermostat is in HEATING mode (flame icon is displaying). To change the thermostat into the COOLING mode – press and hold the SNOWFLAKE button for 5 seconds.

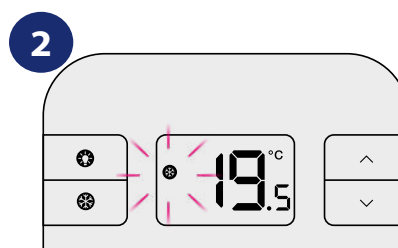

When thermostat is switched to the COOLING mode – the snowflake icon is steady ON. If thermostat is CALLING for COOL – then the snowflake icon is flashing.

HOW TO SET HEATING MODE:

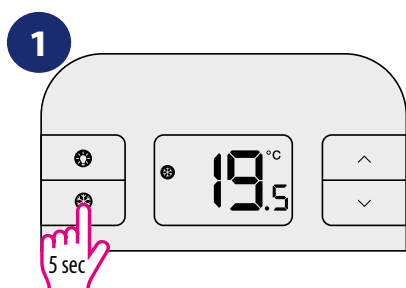

To change the thermostat into the HEATING mode – press and hold the SNOWFLAKE button for 5 seconds.

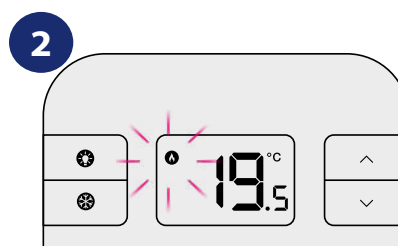

When thermostat is switched to the HEATING mode – the flame icon is steady ON. If thermostat is CALLING for HEAT – then the flame icon is flashing.

* Function available only from firmware version 2.1

5.5 Temperatures outside operating range

Temperatures below 10 °C are displayed without the leading '0'. Temperatures exceeding the measurable range will be indicated by 'HI' for temperatures above the upper limit, and 'LO' for temperatures below the lower limit, as shown in the images.

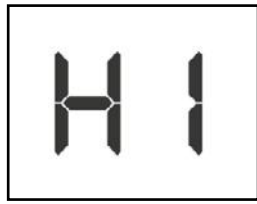





5.6 Low battery detection



Battery voltage is checked every minute. When the battery voltage drops to a certain level, the Low-Battery warning  indicator appears.



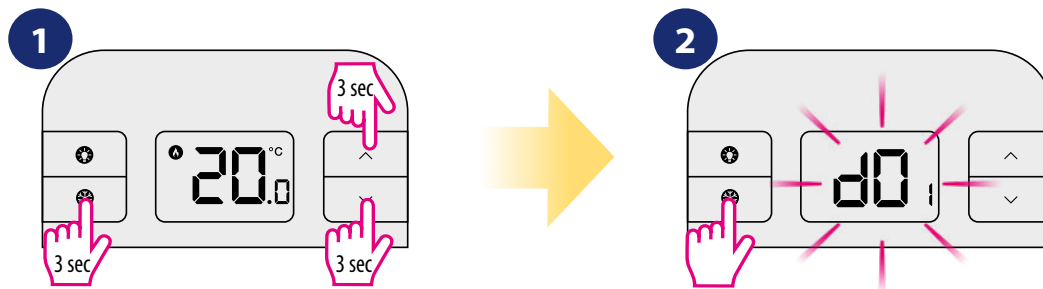

- The thermostat functions normally during low battery. However, user must change the batteries as soon as possible before the battery is too weak for the normal operation to be assured.
- When you change the batteries, you have about 30 seconds to do so without losing your settings.

6. Installer mode

To enter installer parameters please follow steps below. Please refer to parameters table description before any changes. Use  button to move through parameters. Use  or  for adjustments. Every change/selection confirm by  button.



Press and hold  +  +  simultaneously for about 3 seconds to enter the installer mode.

Use  button to move through parameters. Use  or  for adjustments. Every change/selection confirm by  button.

DETAILED TABLE WITH ALL INSTALLER PARAMETERS:

dx	Function	Parameter	Default value
d01	Temperature display accuracy	0.1°C or 0.5°C	0.5°C
d02	Temperature offset	+/- 3.0°C	0.0°C
d03	Frost Protection setpoint temperature	5.0°C - 17.0°C	5.0°C

6.1 DIP switches parameters

DIP switches are used to set chosen control algorithm. They are located under back cover of the thermostat (please refer to the picture below):

The position of the DIP switches determines the type of control algorithm:

1	2	Cooling *	Heating	Default value
ON	ON	Hysteresis +/- 0.25	Hysteresis +/- 0.25	
OFF	ON	Hysteresis +/- 1.5	Hysteresis +/- 0.5	
ON	OFF	Hysteresis +/- 1.0	TPI 9 CPH	
OFF	OFF	Hysteresis +/- 0.5	TPI 6 CPH	✓

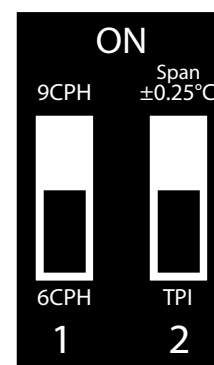

 **PLEASE NOTE!** TPI algorithm is recommended for underfloor heating. It can be adjusted between a low comfort level (6 CPH) and a higher comfort level (9 CPH). „CPH” means cycles per hour and it relates to the frequency of the measurement cycles performed by thermostat.

* Function available only from firmware version 2.1

7. RT310TX thermostat pairing with the receiver

The word PAIRING in the user settings means the function of synchronizing the transmitter with the receiver again, if it has been removed.



WARNING!

IN THE SET RT310RF THE THERMOSTAT IS FACTORY PAIRED WITH THE RECEIVER!

In order to pair the devices correctly, you must first prepare the receiver for synchronization!

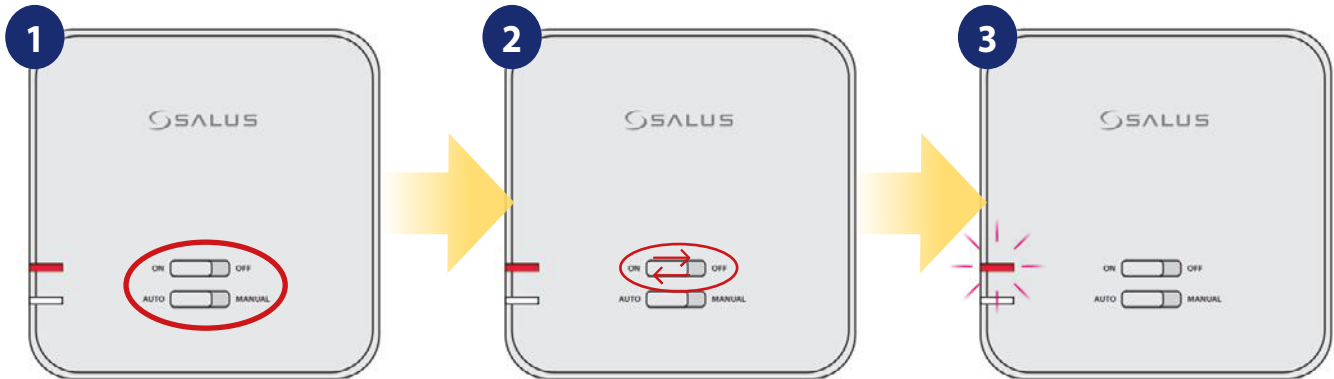

If you want to re-pair the devices with each other, make sure that the receiver is disconnected from the power supply and the switches on it are in the AUTO and ON positions. Then connect the receiver to the power supply and wait for the red diode to glow continuously.

Move the top switch to the OFF position with a quick motion and back to the ON position.

The red LED will start blinking, which will confirm that the receiver has entered the pairing mode.

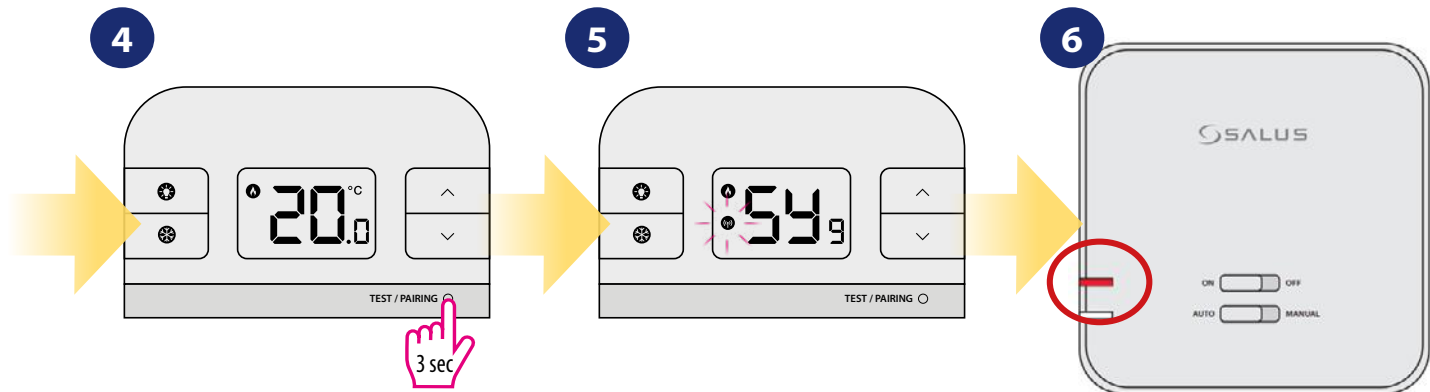

Press and hold TEST / PAIRING button for 3 seconds.

Thermostat started pairing process. It can take up to 9 minutes.

When the red diode on the receiver lights up continuously, the devices have been paired on a new frequency.

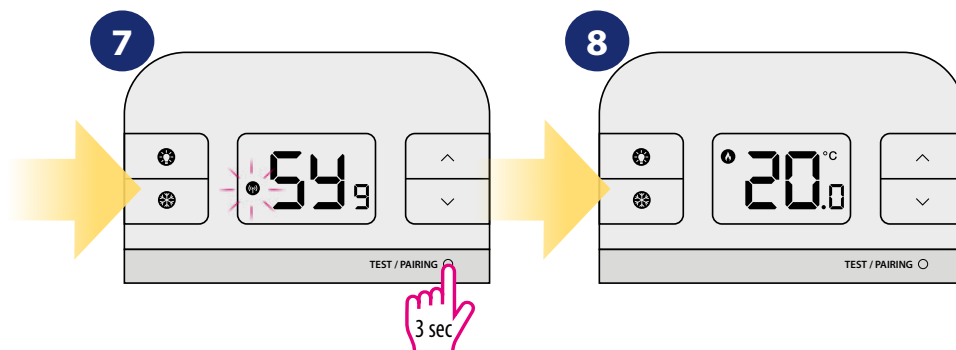

Press and hold TEST / PAIRING button for 3 seconds to end pairing process.

Thermostat will go back to the main screen and it has been paired successfully.

8. Test the pairing process

It is important to place the receiver and transmitter in places where nothing interferes with the radio signal. The range of communication between the transmitter and the receiver in an open area is up to 60m. The radio transmission is influenced by many factors that can shorten the working distance, such as thick walls, drywall covered with aluminum foil, metal objects such as cabinets, general radio interference, etc. However, the range is sufficient for most domestic use. It is recommended to test the radio transmission between devices before mounting the regulator on the wall. The test can be performed by changing the set temperature, i.e. by activating or deactivating the heating.

1

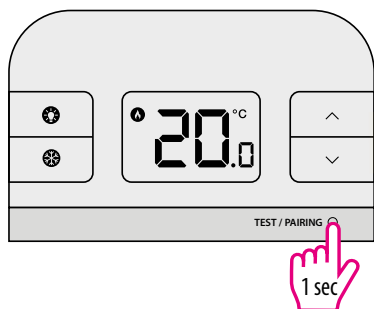

Press TEST / PAIRING button to check the connection with the receiver.

2

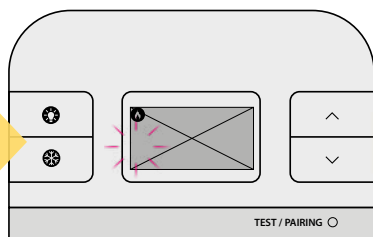

Antenna icon will display. Test mode can take up to 9 minutes.

3

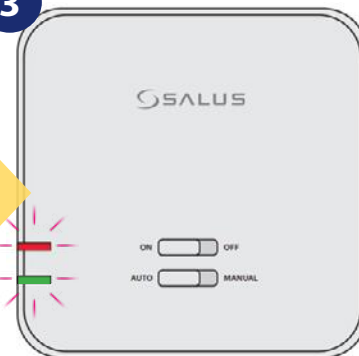

The red LED and the green LED on the receiver will begin to flash.

4

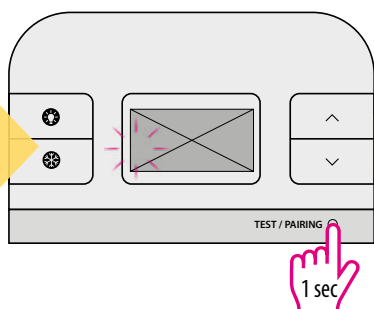

Press TEST / PAIRING button again to return to the main screen.

5

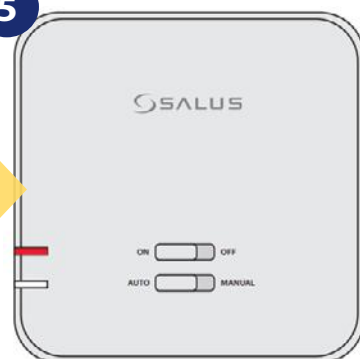

Receiver will go back to normal work mode.



If you purchased an RXRT510 or RT310TX and intend pairing with other devices in the 5x5 range, please refer to the Receiver Units manual or the relevant manuals available at www.salus-controls.eu

9. Reset function

To RESET RT310TX thermostat please follow steps below:

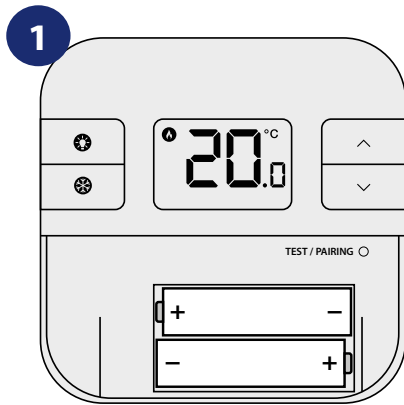

Remove the batteries without pressing any button. Wait 2 minutes and insert the batteries again. Your device will be restarted.



When you want to change the batteries your device will use the internal memory to backup your settings. You have 30 seconds to change the batteries before losing your settings.

10. Cleaning and Maintenance

The **RT310RF thermostat** requires no special maintenance. Periodically, the outer casing can be wiped clean using a dry cloth (please **DO NOT** use solvents, polishes, detergents or abrasive cleaners, as these can damage the thermostat). There are no user serviceable parts within the unit; any servicing or repairs could only be carried out by **Salus Controls** or their appointed agents.

11. Technical Informations

Transmitter's power supply	2 x AA batteries
Receiver's power supply	230V AC 50 Hz
Rating max	16 (5) A
Output signal	NO/COM relay
Temperature range	5 - 35°C
Display temperature accuracy	0.1°C or 0.5°C
Control algorithm	TPI or Hysteresis: $\pm 0.25^{\circ}\text{C}$, $\pm 0.5^{\circ}\text{C}$, $\pm 1.0^{\circ}\text{C}$ or $\pm 1.5^{\circ}\text{C}$
Communication	Wireless, 868Mhz
Dimension [mm]	transmitter: 96 x 96 x 27 receiver: 96 x 96 x 27

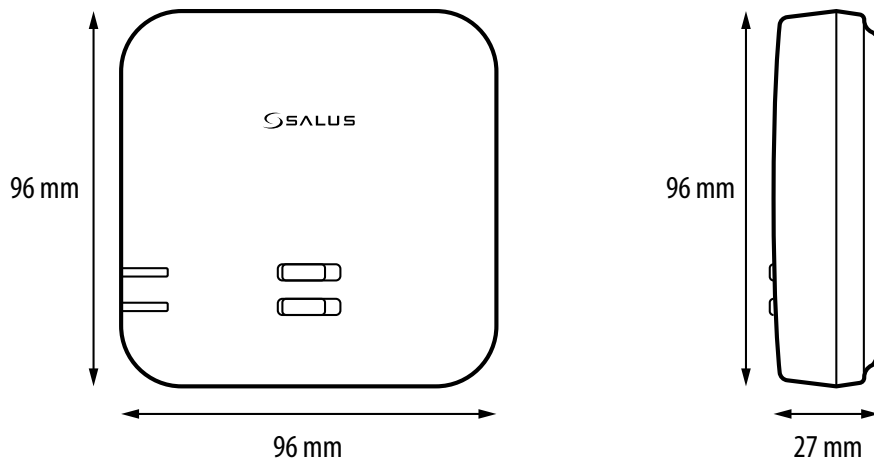
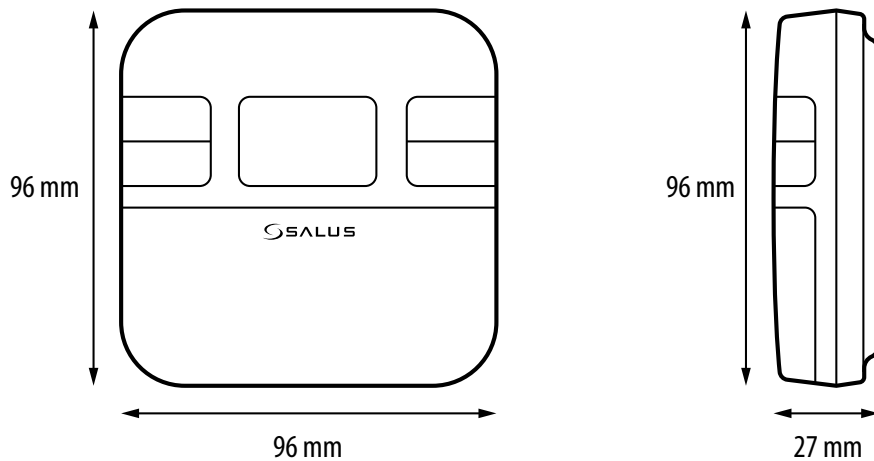

12. Warranty

SALUS CONTROLS warrants this product to be free from any defects in material or workmanship and to perform as specified for a period of five years from the date of installation. SALUS CONTROLS reserves the sole responsibility for breach of this warranty by repairing or replacing the defective product. This product includes software that matches the distributor's identification at the time of sale. The manufacturer / distributor provides a guarantee covering all functions and specifics of the product in accordance with this marking. The distributor's warranty does not cover the correct operation of the functions and features available as a result of a product software update.

The full warranty conditions are available at www.salus-controls.eu

Customer Name:

Customer Address:

..... Post Code:

Tel No: Email:

Company Name:

Tel No: Email:

Installation Date:

Installer Name:

Installer Signature:

DISTRIBUTOR OF SALUS CONTROLS:

QL CONTROLS Sp. z o.o., Sp. k.

Rolna 4,

43-262 Kobielice,

Poland

IMPORTER:

SALUS Controls Plc

Units 8-10 Northfield Business Park

Forge Way, Parkgate

Rotherham

S60 1SD

United Kingdom



www.salus-controls.com

SALUS Controls is a member of the Computime Group.

Maintaining a policy of continuous product development SALUS Controls plc reserve the right to change specification, design and materials of products listed in this brochure without prior notice.

Ver. 5

Issued: 23 XII 2020

Soft version: 2.1

